

PARTS

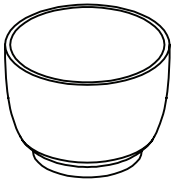

A x 1

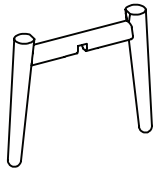

B x 1

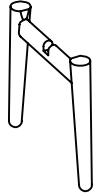

C x 1

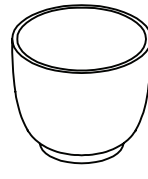

D x 1



E x 1

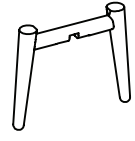

F x 1



G x 8

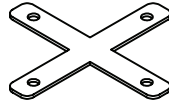

H x 2

STEP 1

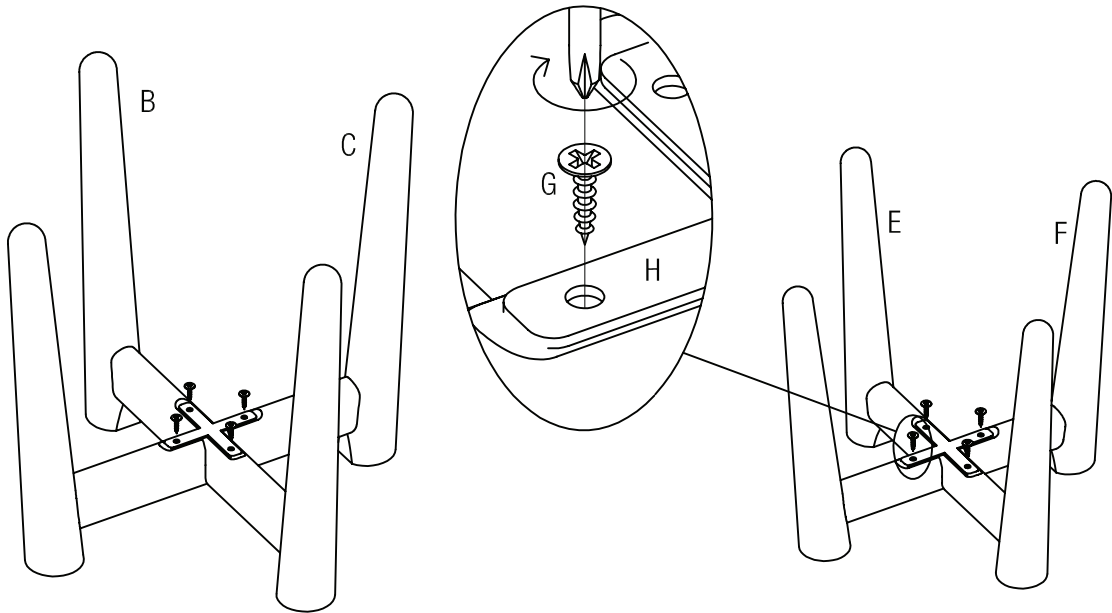

STEP 2

